

# FORNEBU ARENA EN NY MØTEPlass FOR IDRETT OG KULTUR

PRESENTASJON PLANUTVALGET BÆRUM KOMMUNE  
10.12.20  
RASMUS SANDNES, EUFORUM HOLDING

Reiulf  
Ramstad  
Arkitekter  
Sameiet  
Widerøeveien 1

# BAKGRUNN

- TA bygd kun til ett formål – fotball full størrelse/ elitenivå
- Egner seg ikke til andre formål – ikke bærekraftig drift
- Fungerer bare til de aller største arrangementene – ikke skallerbar
- Derfor veldig lavt antall arrangement i løpet av året – ca 30. Sammenlignbare arenaer 90 – 120 arrangement
- Toppåret 2018 – ca 400 000 besøkende, sammenlignbare arenaer ca 1 mill

# STATUS

- Telenor Arena har, i samarbeid med Norges Håndballforbund, jobbet i to år med planer om både inn- og utvendig redesign. Prosjektet går videre i full fart, selv om arenaen i praksis har vært nedstengt siden mars på grunn av koronapandemien.
  - Hovedarena med plass til 20 000 tilskuere på konsert, og 15 000 på eliteidrett. Dette vil bli en ny og etterlengtet nasjonalarena for håndball og andre innendørsidretter, og også kunne huse konserter, eventer, idrettsbegivenheter og messer av internasjonalt format
  - Én sportsarena med tilskuerkapasitet på 2000 for både idrett og kultur (topp og bredde)
  - To flerbrukshaller tilpasset behovene til nærområdets skoler og breddeidrettslag
  - Andre aktivitetsarealer tilgjengelig for idrett og kultur
  - Øvrig utadrettet virksomhet og servicetilbud
- Oppsummert
  - Et helt nytt konsept som skal ende i nasjonalarena for håndball, samt bli et senter for både store kulturarrangementer og for bredde- og lokalidretten.
  - I den nye arenaen skal vi gjøre mer av det samme som vi har gjort til nå, i tillegg til alt det nye vi har mulighet for å arrangere.

# VISJON



menneskevennlig  
og trivelig

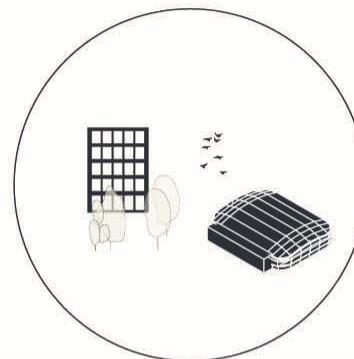

Fornebu sitt vakreste, mest  
forseggjorte, fargerike og  
stedstilpassede nabolag

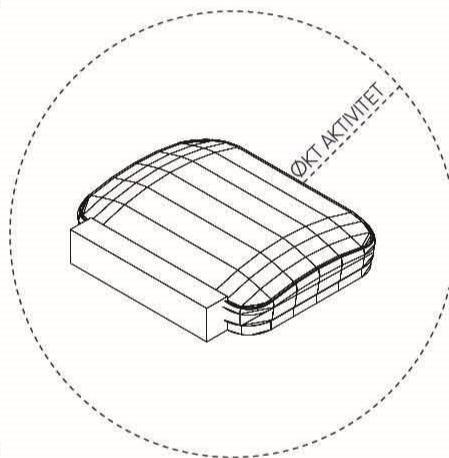

FORNEBU  
ARENA

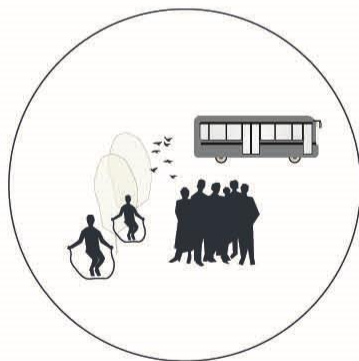

et godt sted å være, å  
å sosialisere, å bo

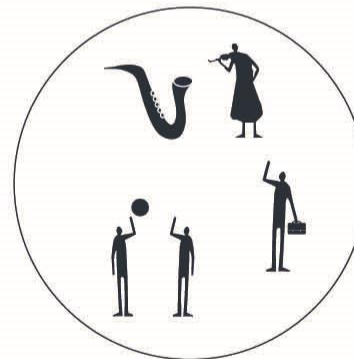

et variert program

Sameiet  
Widerøeveien 1

Reiulf  
Ramstad  
Arkitekter  
10.12.20

# EN NY DESTINASJON

- ET NYTT SENTER FOR IDRETT OG KULTUR
- SKAPE ET SENTER FOR DAGLIG BRUK.  
EN FREMTIDSRETTET AKTIV DESTINASJON PÅ FORNEBU
- EN NY MØTEPLASS:  
LOKALT-REGIONALT-NASJONALT-INTERNASJONALT
- SAMLINGSPUNKT:  
FOR BARN/VOKSNE-AMATØRER/PROFESJONELLE
- FLERBRUK I ANLEGGET MELLOM ULIKE ROM
- SKALÉRBARHET FRA STORE TIL SMÅ ARRANGEMENT  
IDRETT/KONFERANSE/FESTIVALER/MUSIKK



Sameiet  
Widerøeveien 1

Reiulf  
Ramstad  
Arkitekter  
10.12.20

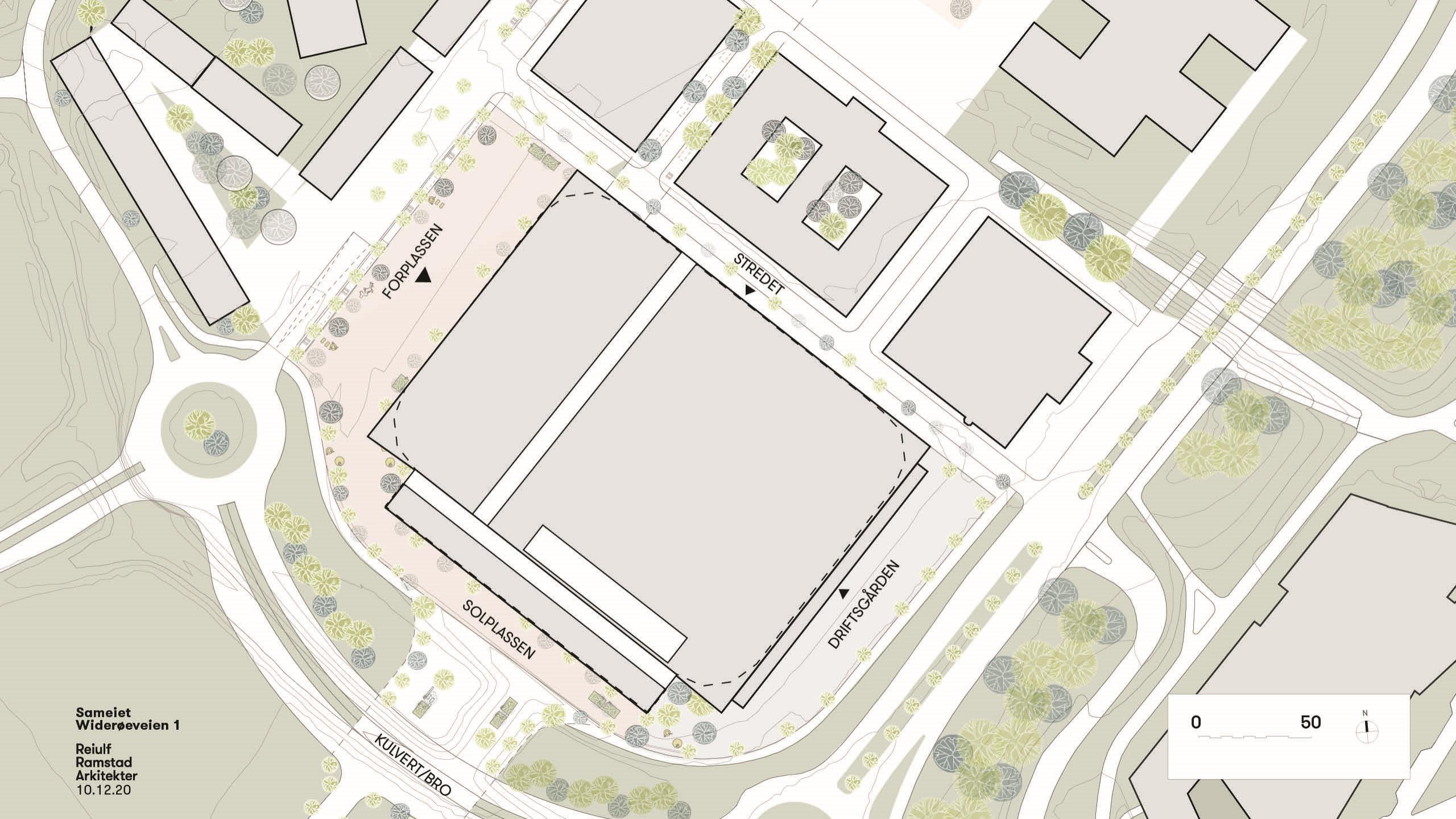

Sameiet  
Widerøeveien 1  
Reiulf  
Ramstad  
Arkitekter  
10.12.20

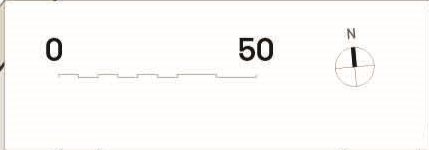

# SOLPLASSEN



GRØNN URBANITET



SMÅ SAMLINGSSTEDER



INTIME UTEPLASSER



ÅPNE FASADER

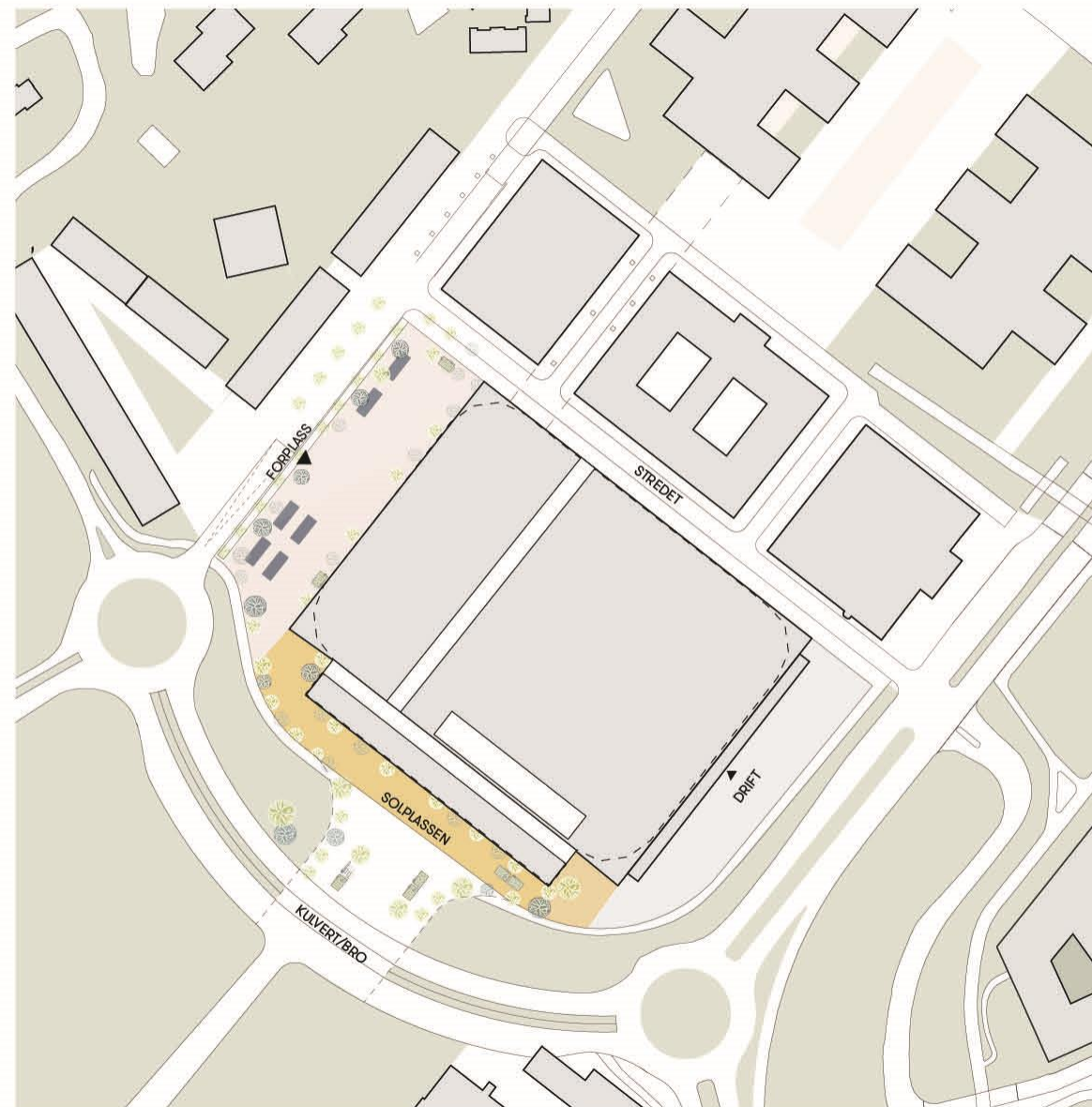

Sameiet  
Widerøeveien 1

Reiulf  
Ramstad  
Arkitekter  
10.12.20

# STREDET



KAFE OG SERVERING



SMÅ NÆRING



VEGETASJON



POP-UP ARRANGEMENT



Sameiet  
Widerøeveien 1

Reiulf  
Ramstad  
Arkitekter  
10.12.20



# FORPLASSEN



SAMLINGSSTED NABOLAG



MØTESTED ARRANGEMENTER



MARKED



AKTIVT BYGULV

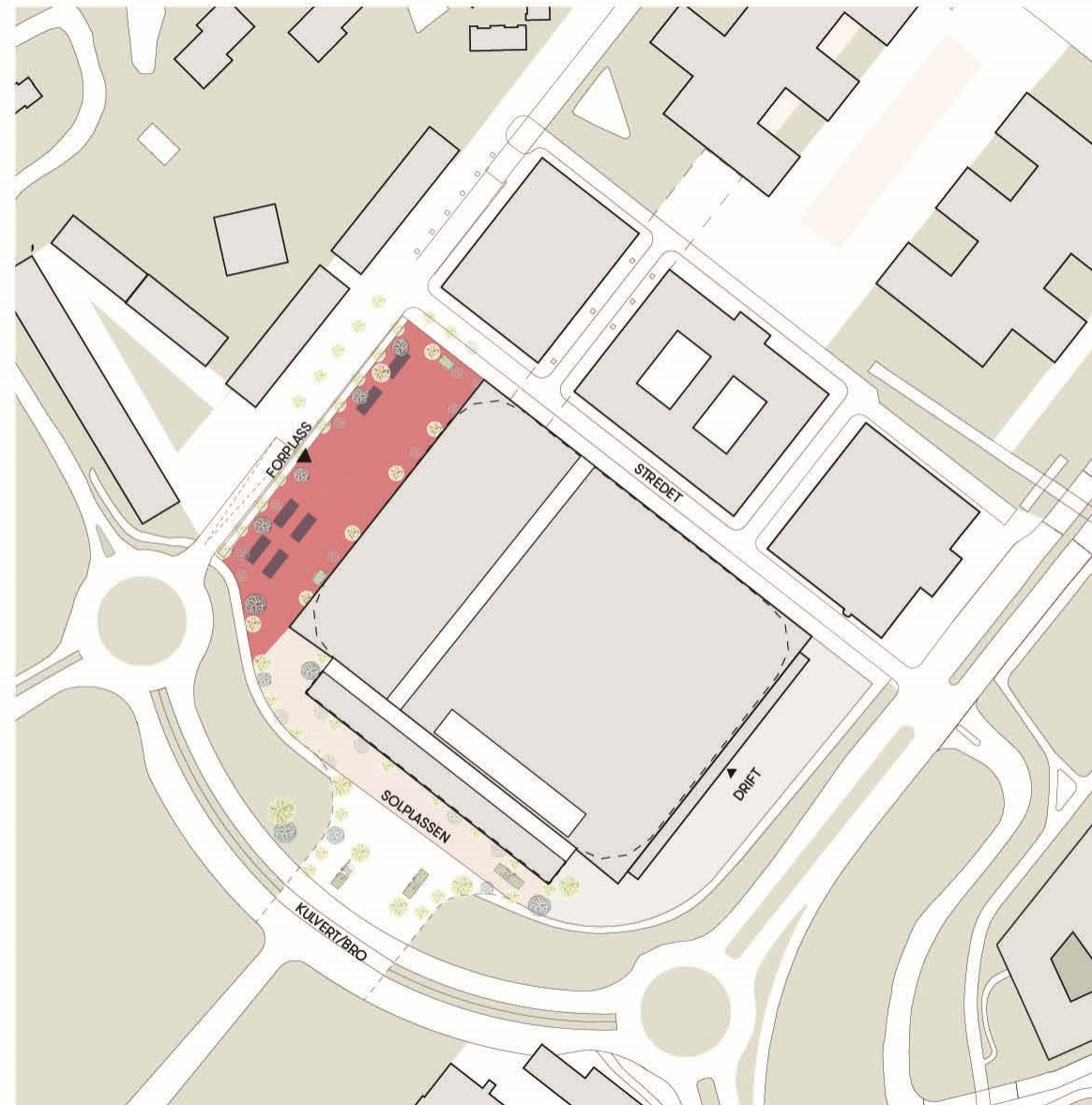

Sameiet  
Widerøeveien 1

Reiulf  
Ramstad  
Arkitekter  
10.12.20



Some  
Widerlevel  
Beit  
Somatid  
Wahkwa  
10.100

# 1 etg

DRIFT+PUBLIKUM

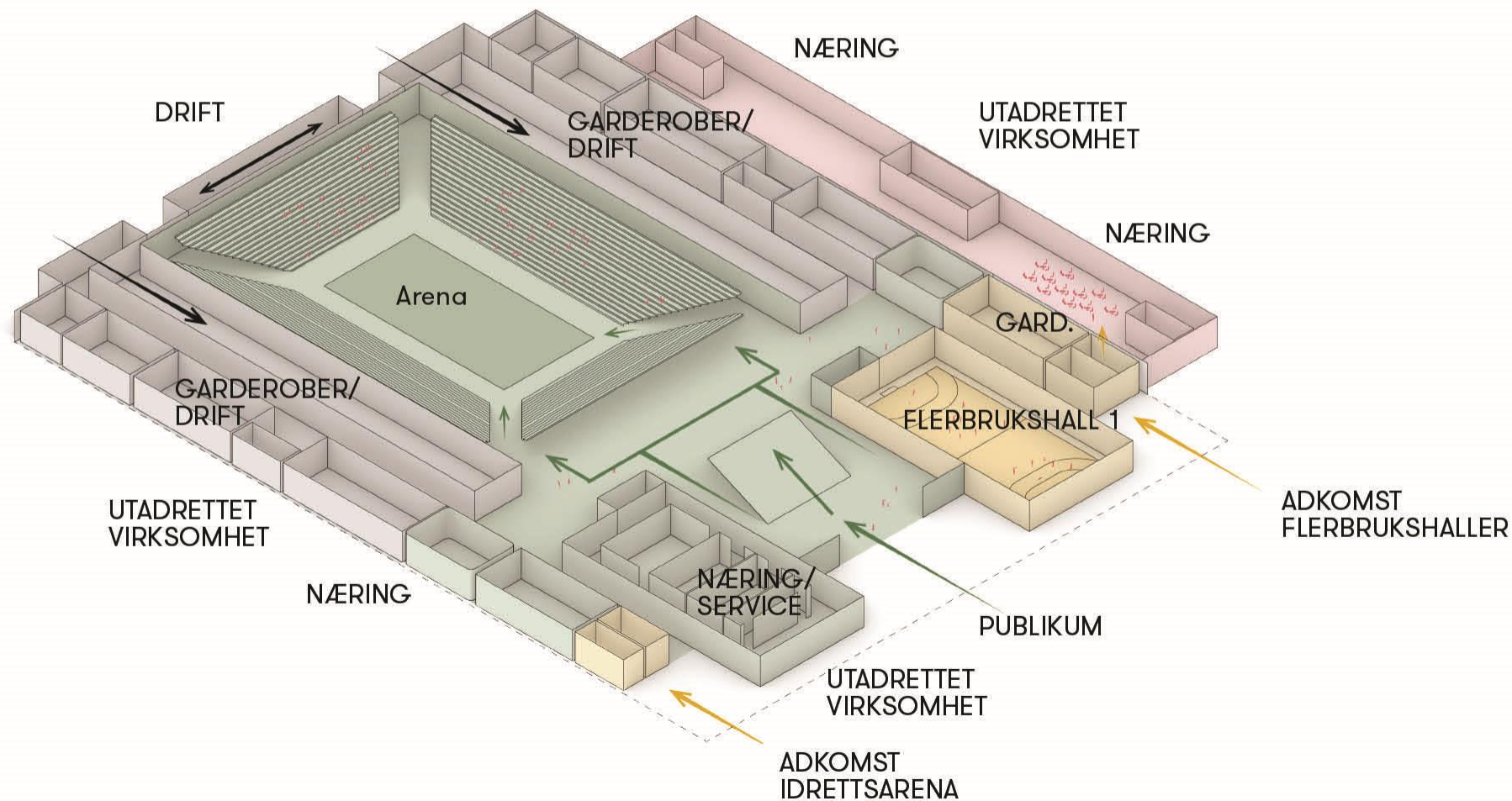

Sameiet  
Widerøeveien 1

Reiulf  
Ramstad  
Arkitekter  
10.12.20

# 2 etg

PUBLIKUM+FLERBRUKSHALLER

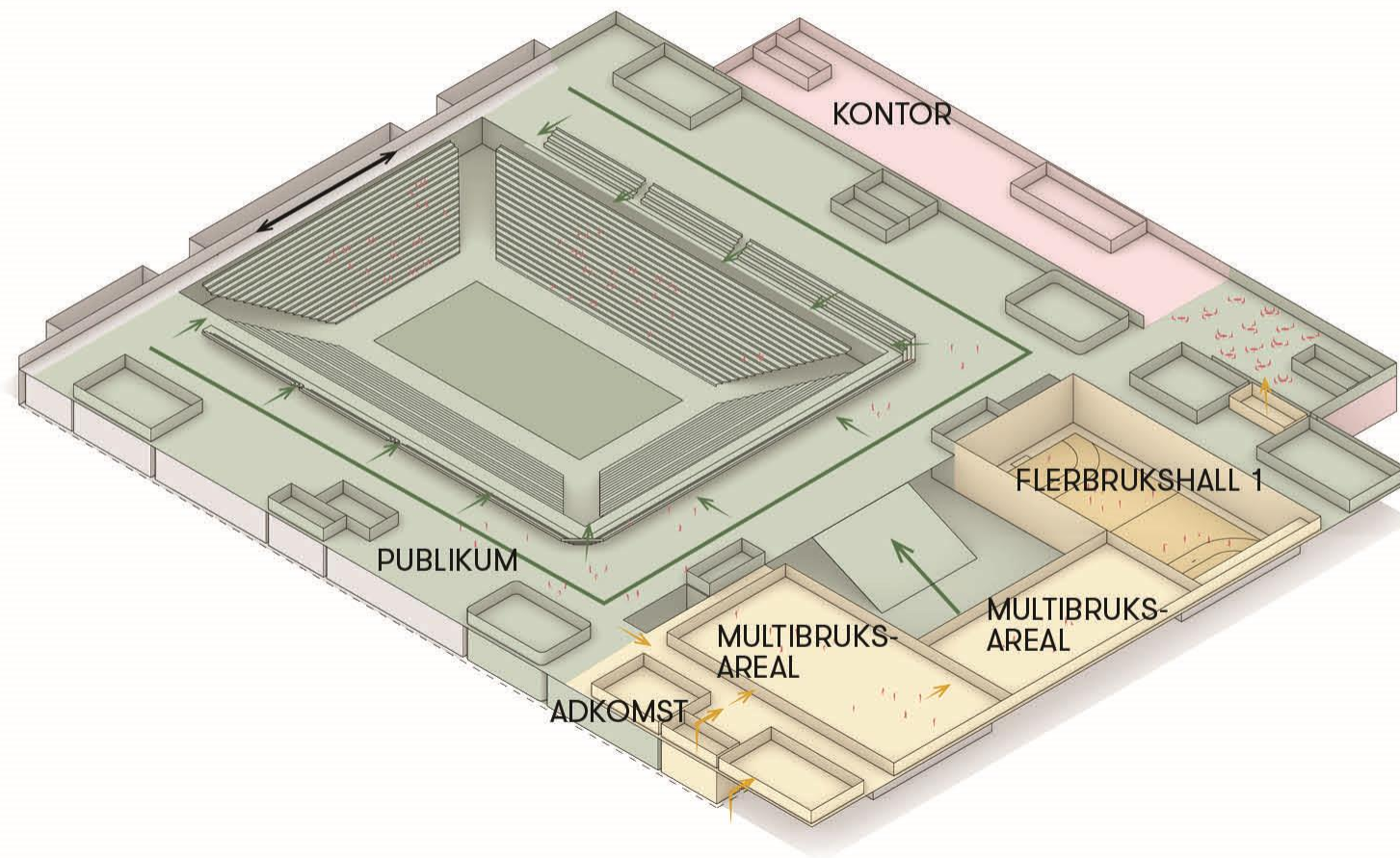

Sameiet  
Widerøeveien 1

Reiulf  
Ramstad  
Arkitekter  
10.12.20

# 3 etg

PREMIUM

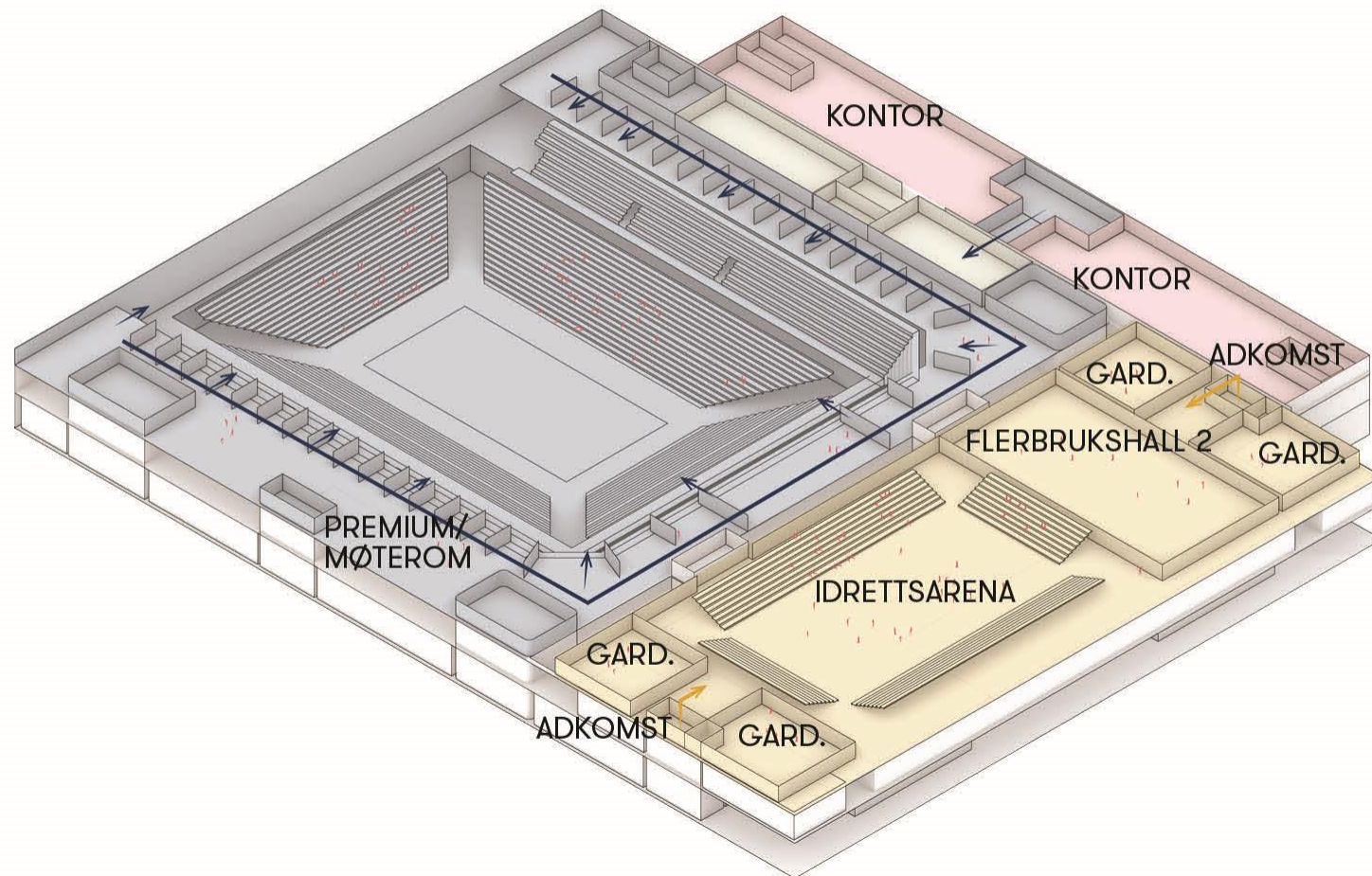

Sameiet  
Widerøeveien 1

Reiulf  
Ramstad  
Arkitekter  
10.12.20

# 4 etg

## UPPER BOWL OG EKSTRAHALL

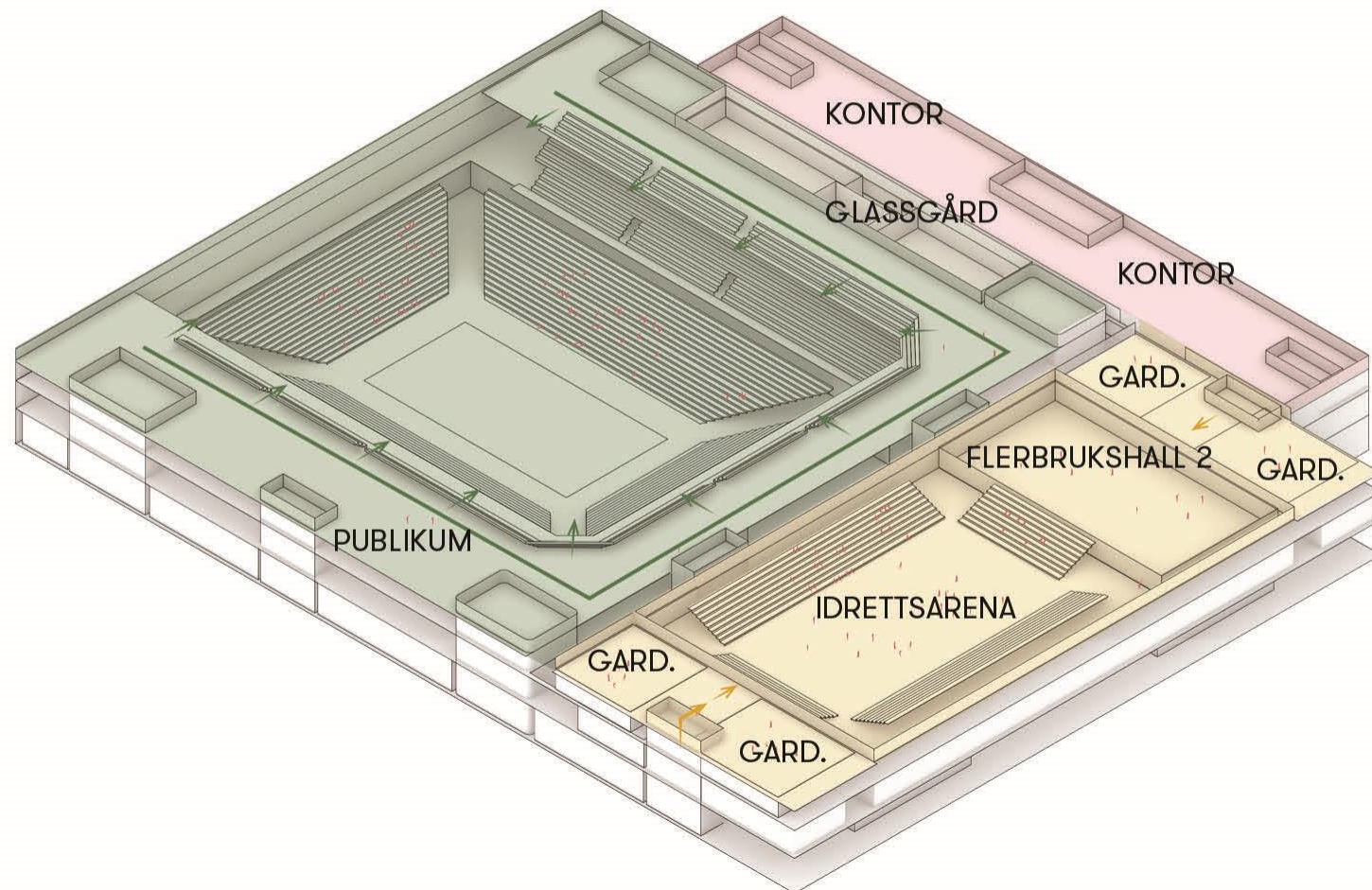

Sameiet  
Widerøeveien 1

Reiulf  
Ramstad  
Arkitekter  
10.12.20

# 5 etg

DRIFT OG SIKKERHETSROM

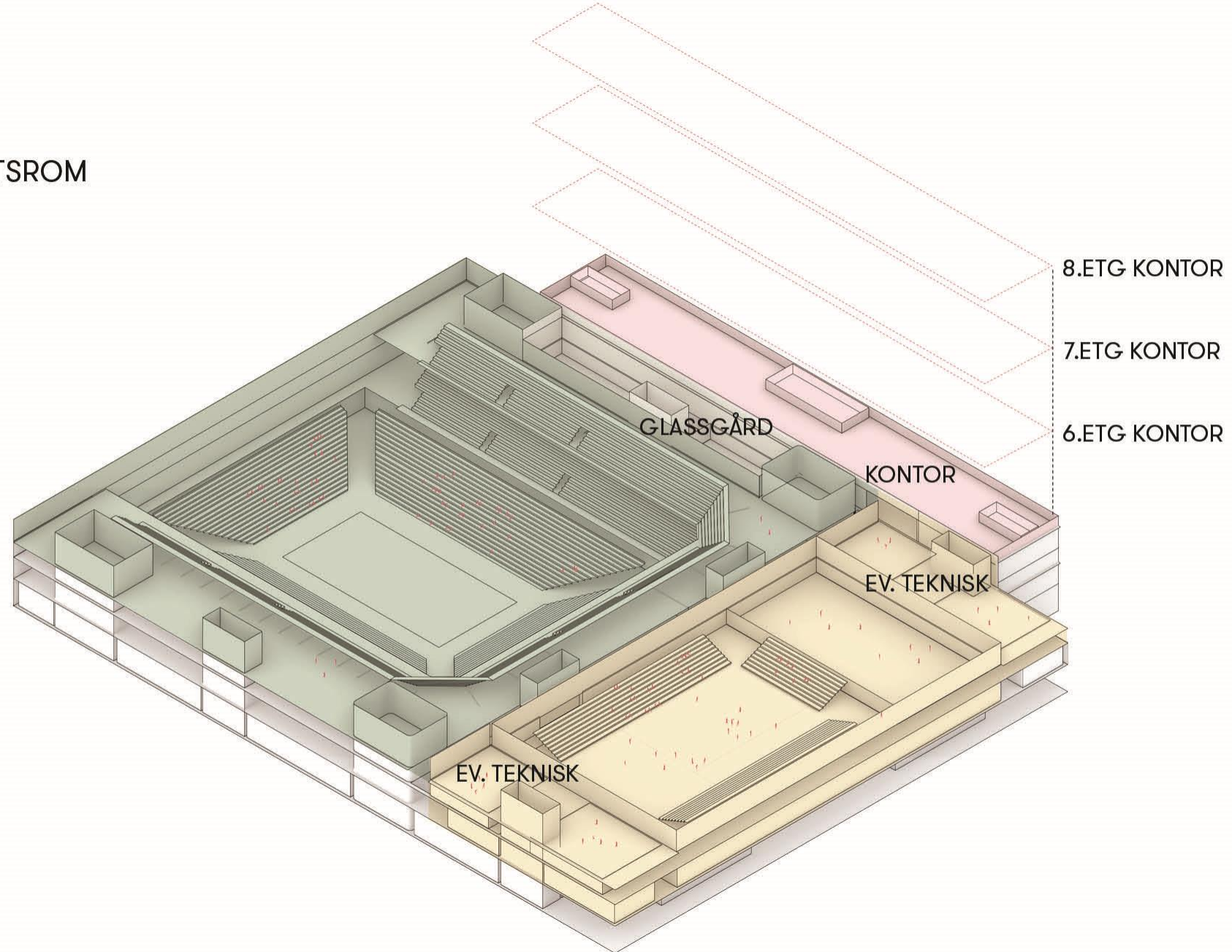

Sameiet  
Widerøeveien 1

Reiulf  
Ramstad  
Arkitekter  
10.12.20

# SIRKULASJONSVERTIKALER

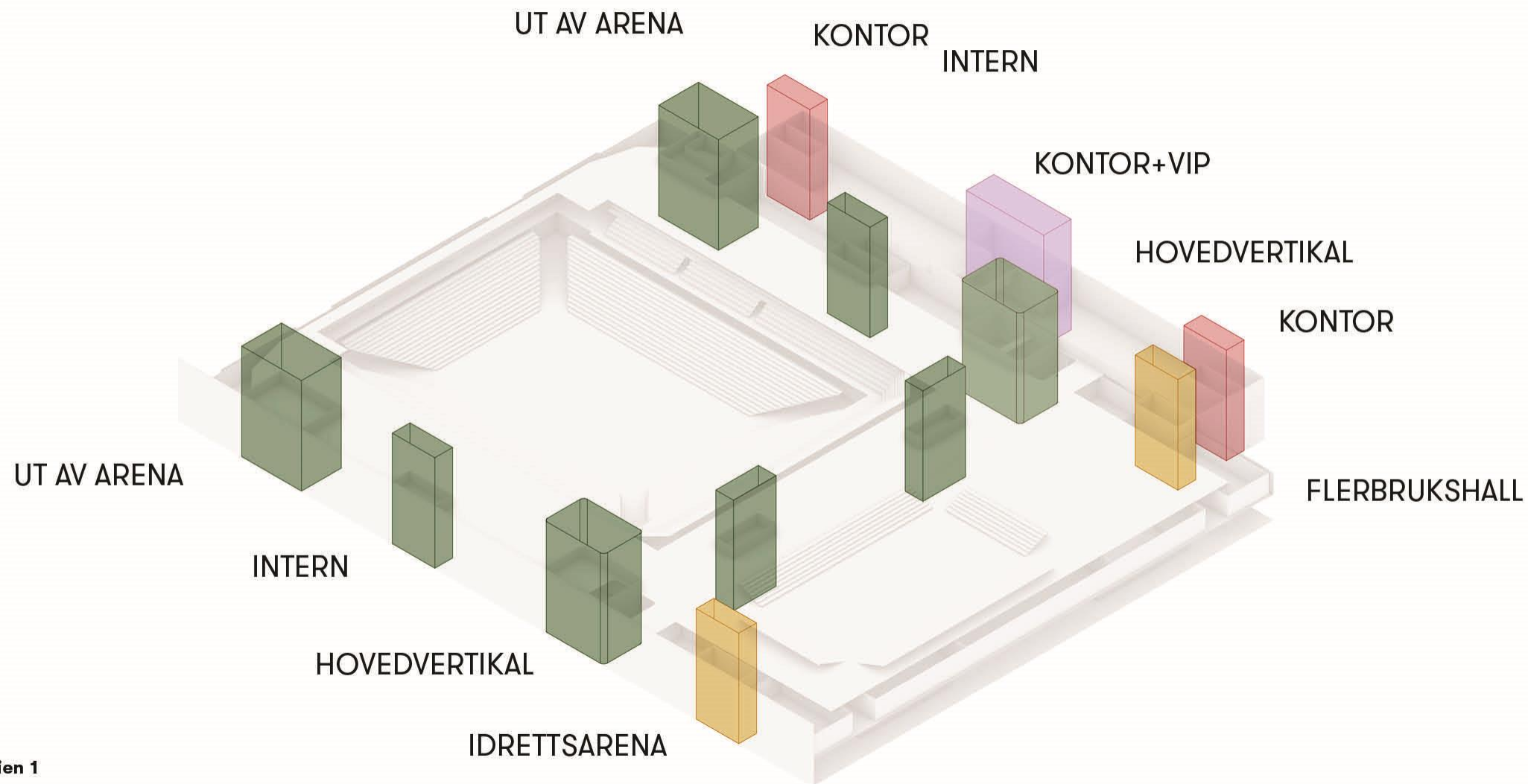

Sameiet  
Widerøeveien 1

Reiulf  
Ramstad  
Arkitekter  
10.12.20





Reiulf  
Ramstad  
Arkitekter  
10.12.20

# SENTER FOR IDRETT

NORGES BADMINTONFORBUND  
NORGES BASKETBALLFORBUND  
NORGES BEDRIFTSIDRETTSFORBUND  
NORGES BILJARDFORBUND  
NORGES BORDTENNISFORBUND  
NORGES BRYTEFORBUND  
NORGES DANSEFORBUND  
NORGES FEKTEFORBUND  
NORGES FLERIDRETTSFORBUND  
NORGES GYMNASTIKK OG TURNFORBUND  
NORGES ISHOCKEYFORBUND  
NORGES KAMPSPORTFORBUND  
NORGES KICKBOXINGFORBUND  
NORGES SQUASHFORBUND  
NORGES STUDENTIDRETTSFORBUND  
NORGES STYRKELOFTFORBUND  
NORGES VEKTLØFTERFORBUND  
NORGES VOLLEYBALLFORBUND

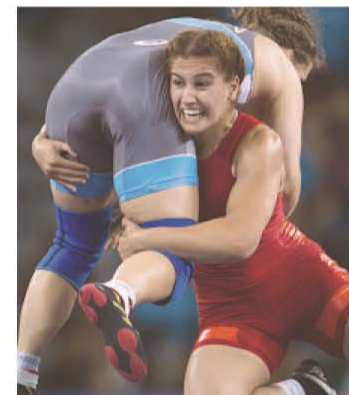

Sameiet  
Widerøeveien 1

Reiulf  
Ramstad  
Arkitekter  
10.12.20

# ARENA



BRUK:

H: 23m

T.SKUER: 15 000\*

\*sittende

NASJONALARENA

IDRETT

KONSERTER

MESSER

CORPORATE EVENTS

KONGRESSER

TV-/FAMILIESHOW

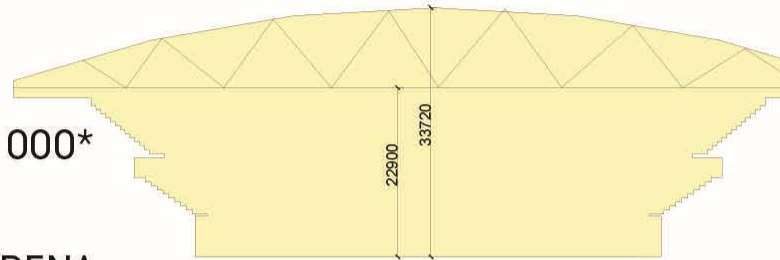

SNITT

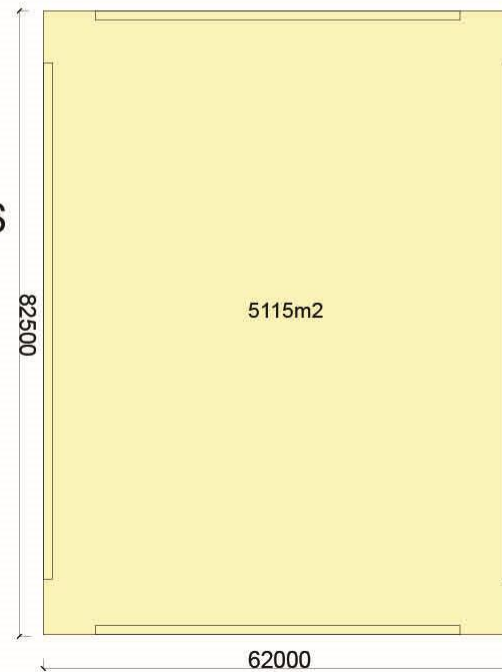

GULVAREAL

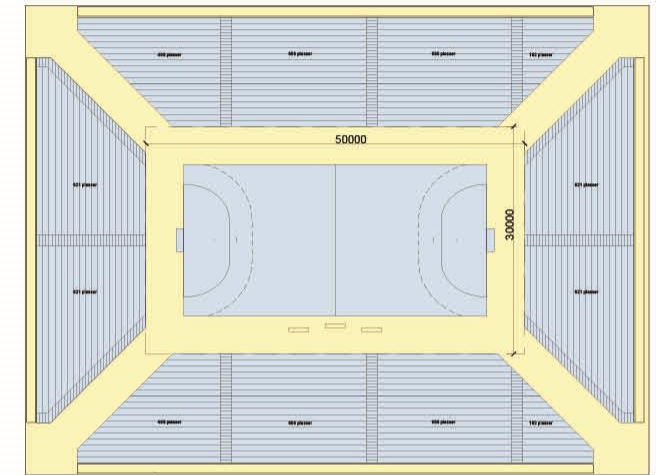

HÅNDBALL FINALEARENA

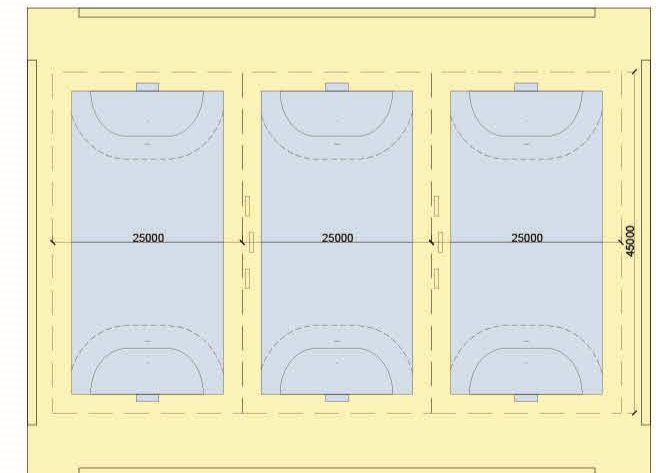

HÅNDBALL ELITENIVÅ

Sameiet  
Widerøeveien 1

Reiulf  
Ramstad  
Arkitekter  
10.12.20

# IDRETTSARENA



BRUK:

H: 9m  
T.SKUER: 2 000

INTERNASJONALE  
KAMPER

NASJONALE KAMPER

ELITEKAMPER

ARRANGEMENT

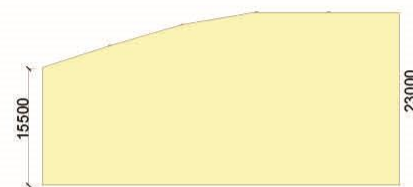

SNITT

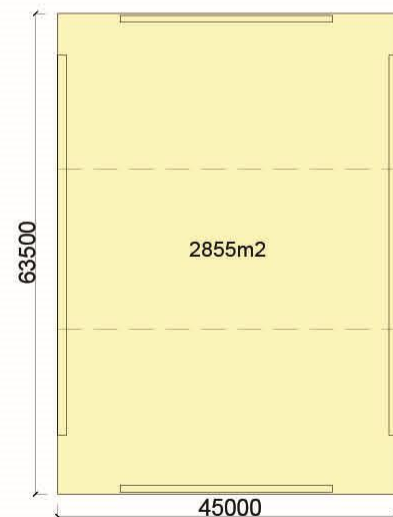

GULVAREAL

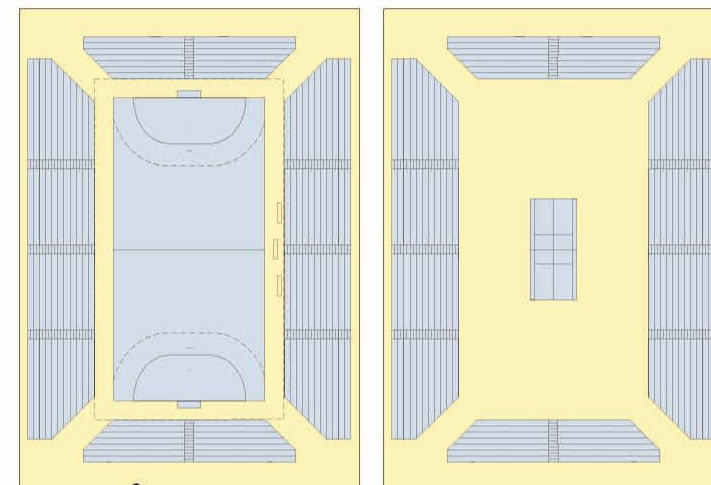

HÅNDBALL

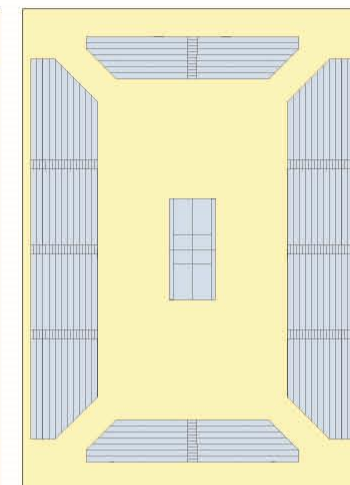

BADMINTON

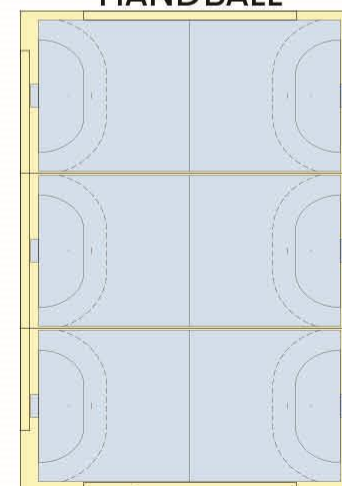

HÅNDBALL

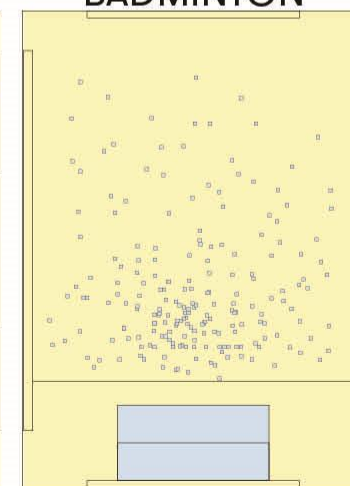

ARRANGEMENT

Sameiet  
Widerøeveien 1

Reiulf  
Ramstad  
Arkitekter  
10.12.20

# FLERBRUKSHALL 1 OG 2



BRUK:

H: 7m  
T.SKUER: 100

SKOLEKLASSER

BREDDEIDRETTER:

- HÅNDBALL
- VOLLEYBALL
- STUDENTIDRETT
- FLERIDRETT
- GYMNASTIKK/ TURN
- BEDRIFTSIDRETT
- BASKETBALL
- BADMINTON

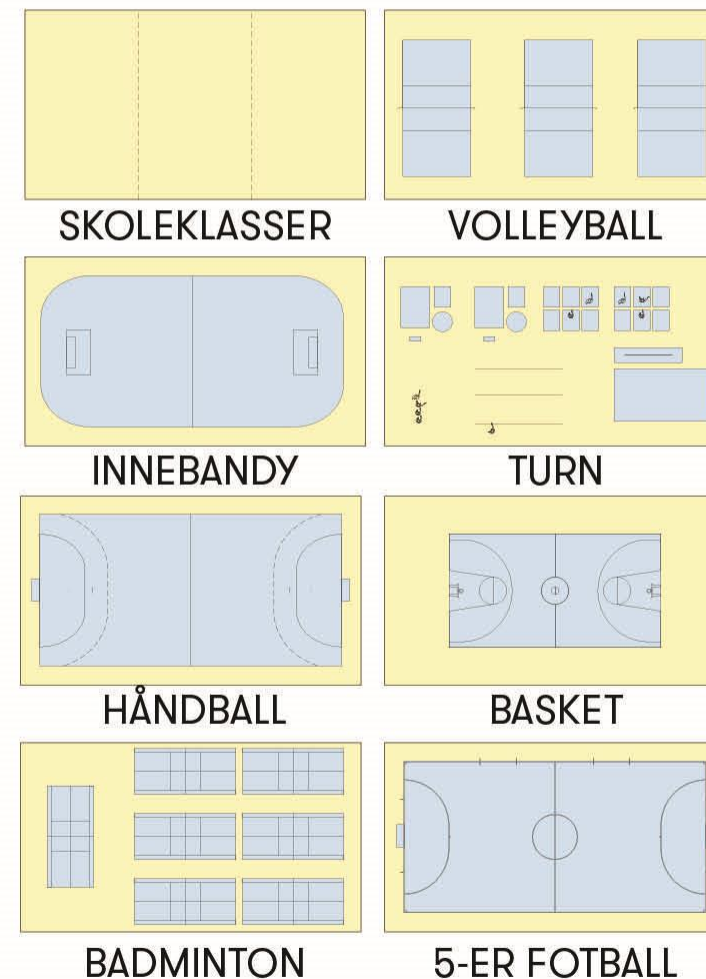
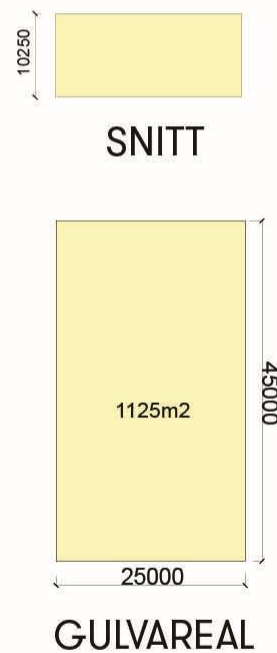

Sameiet  
Widerøeveien 1

Reiulf  
Ramstad  
Arkitekter  
10.12.20

# MULTIBRUKSAREALER



BRUK:

H: 4,5m  
T.SKUER: 0

BREDDEIDRETTER:

- BILJARD
- DANS
- E-SPORT
- BORDTENNIS
- BRYTING
- FEKTING
- KAMPSPORT
- KICKBOXING
- STYRKELØFTING

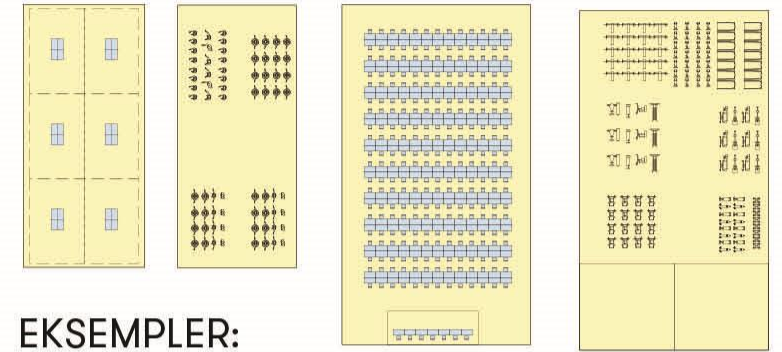
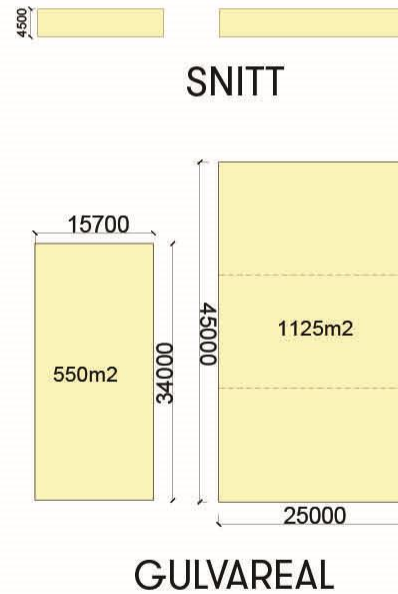

EKSEMPLER:

BORD-  
TENNIS

DANS

E-SPORT

TRENING-  
SENTER

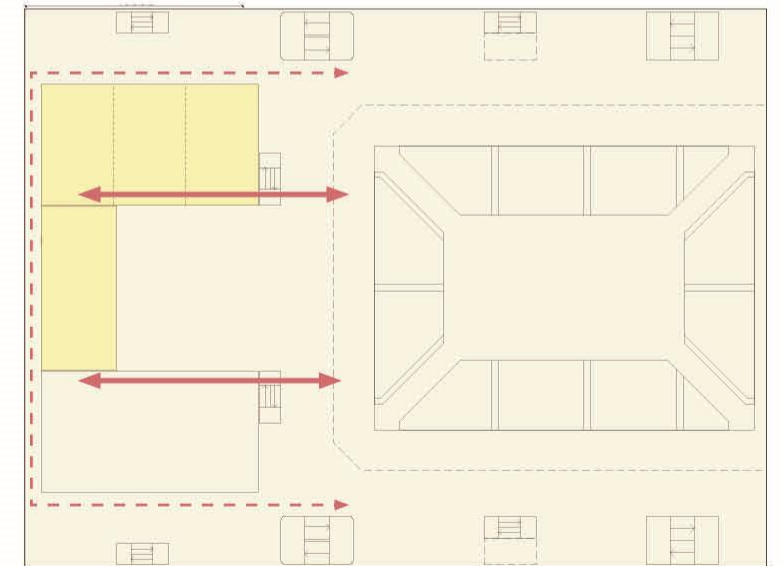

SAMBRUKSMULIGHET MED ARENAEN

Sameiet  
Widerøveien 1

Reiulf  
Ramstad  
Arkitekter  
10.12.20



# SNITT AA

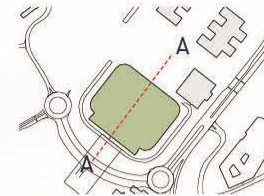

Sameiet  
Widerøveien 1

Reiulf  
Ramstad  
Arkitekter  
10.12.20

0 15



# SNITT BB

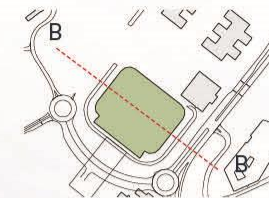

O.K. TAK +52.00

PLAN 5 +39.00

PLAN 4 +31.95

PLAN 3 +28.75

PLAN 2 +23.75

PLAN 1 +18.00



Sameiet  
Widerøeveien 1

Reiulf  
Ramstad  
Arkitekter  
10.12.20

0 15

# SNITT CC

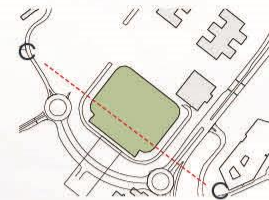

O.K. TAK +52.00

PLAN 5 +39.00

PLAN 4 +31.95

PLAN 3 +28.75

PLAN 2 +23.75

PLAN 1 +18.00



Sameiet  
Widerøeveien 1

Reiulf  
Ramstad  
Arkitekter  
10.12.20

0 15

# FASADEMATERIELL

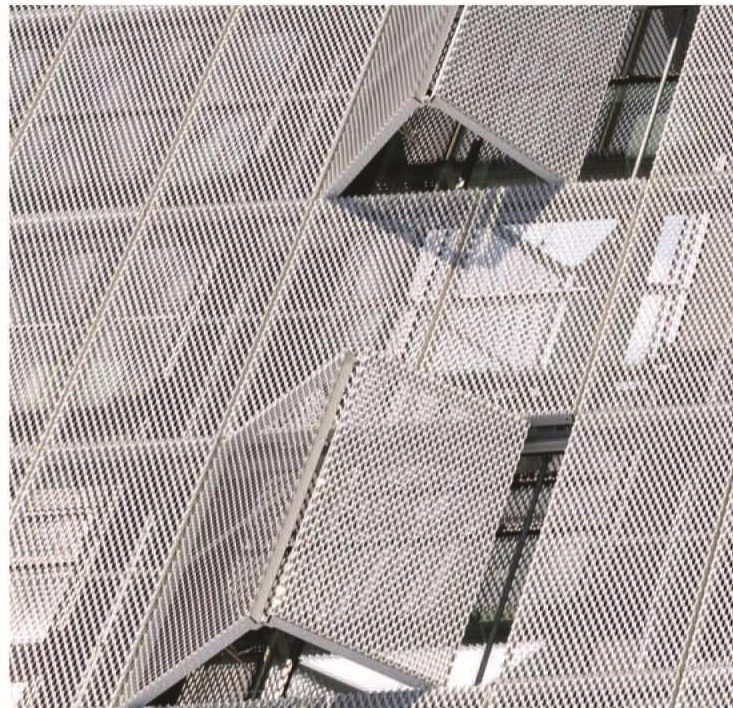

Sameiet  
Widerøveien 1

Reiulf  
Ramstad  
Arkitekter  
10.12.20

# FASADE VEST

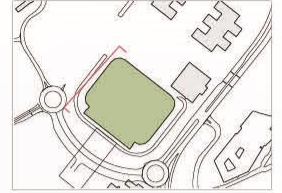

Sameiet  
Widerøveien 1  
Reiulf  
Ramstad  
Arkitekter  
10.12.20



# AREALOVERSIKT

	Eksisterende reguleringsbestemmelser	Nytt prosjekt
Arena + tribune	19 700	13 200
Drift av arena inkl. kontorbygget	18 550	30 000
Plasskrevende handel	2 550	
Kombinert bebyggelse og anleggsformål, arenatilknyttet virksomhet, forretning m.v		11 950
Idrettsformål		12 100
<b>Totalt</b>	<b>40 800</b>	<b>67 250</b>

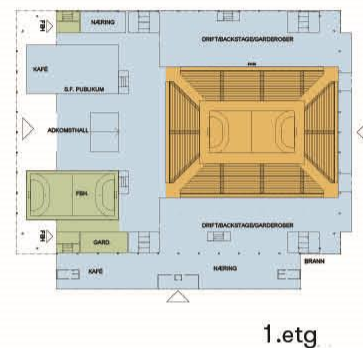
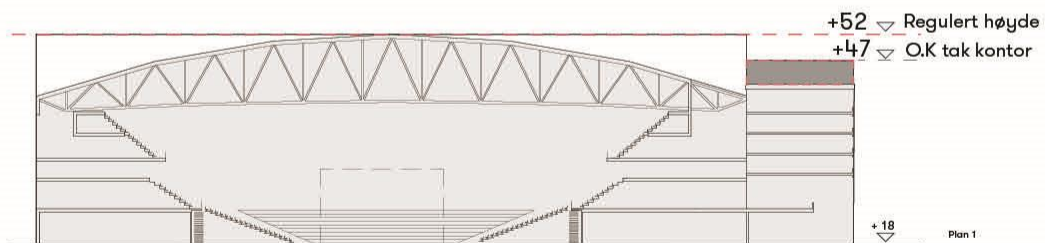

1.etg

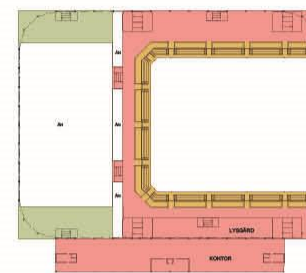

4.etg

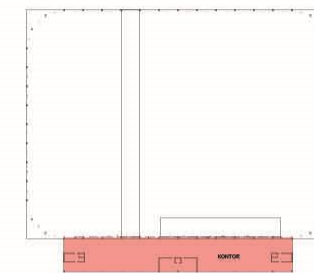

7.etg

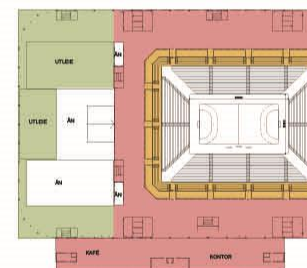

2.etg

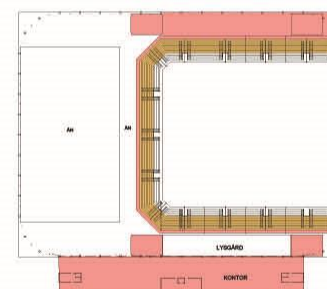

5.etg

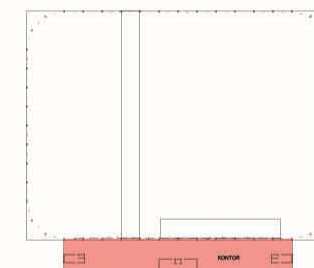

8.etg

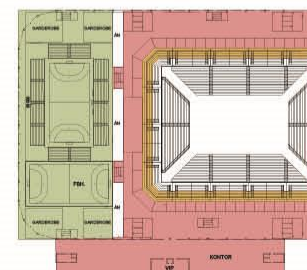

3.etg

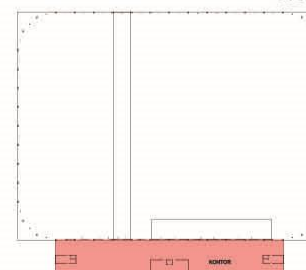

6.etg

Sameiet  
Widerøeveien 1

Reiulf  
Ramstad  
Arkitekter  
10.12.20

# OPPSUMMERING

- Fornebu trenger aktiviteter og møteplass for alle aldersgrupper
- Bærum trenger flater for bredde og skole
- Hallidrettene trenger flater for ulike formål
- NHF trenger Nasjonalarena
- Norge trenger en arena med internasjonalt format
- MEN – vi har dårlig tid om vi skal klare å gjennomføre finaler VM Håndball herrer i januar 2025

Sameiet  
Widerøveien 1

Reiulf  
Ramstad  
Arkitekter  
10.12.20

10.12.2020  
FORNEBU ARENA

TELENOR ARENA

Reiulf  
Ramstad  
Arkitekter

Sameiet  
Widerøeveien 1

# PLAN 1

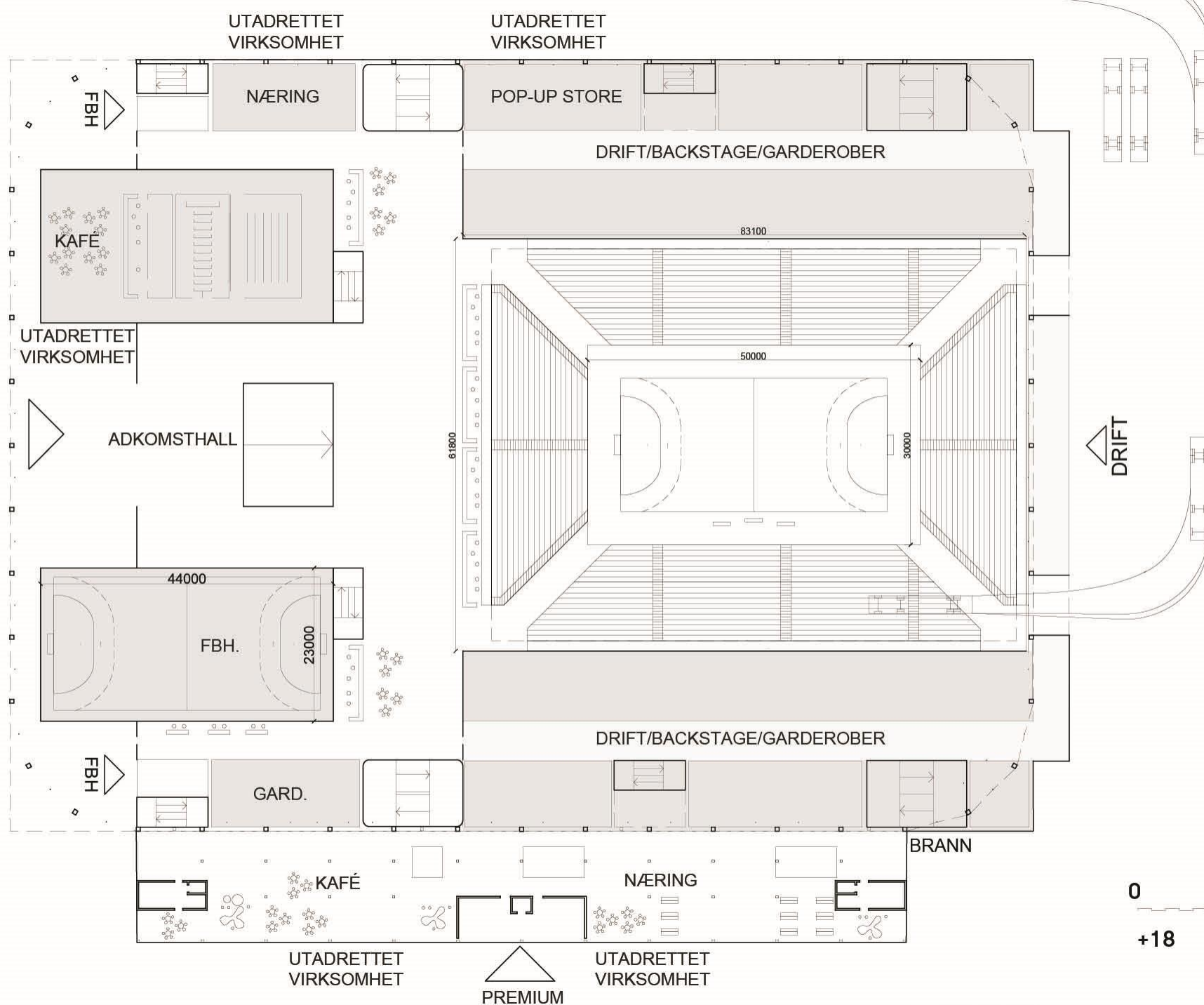

Sameiet  
Widerøeveien 1

Reiulf  
Ramstad  
Arkitekter  
10.12.20

0 20  
+18





# PLAN 2

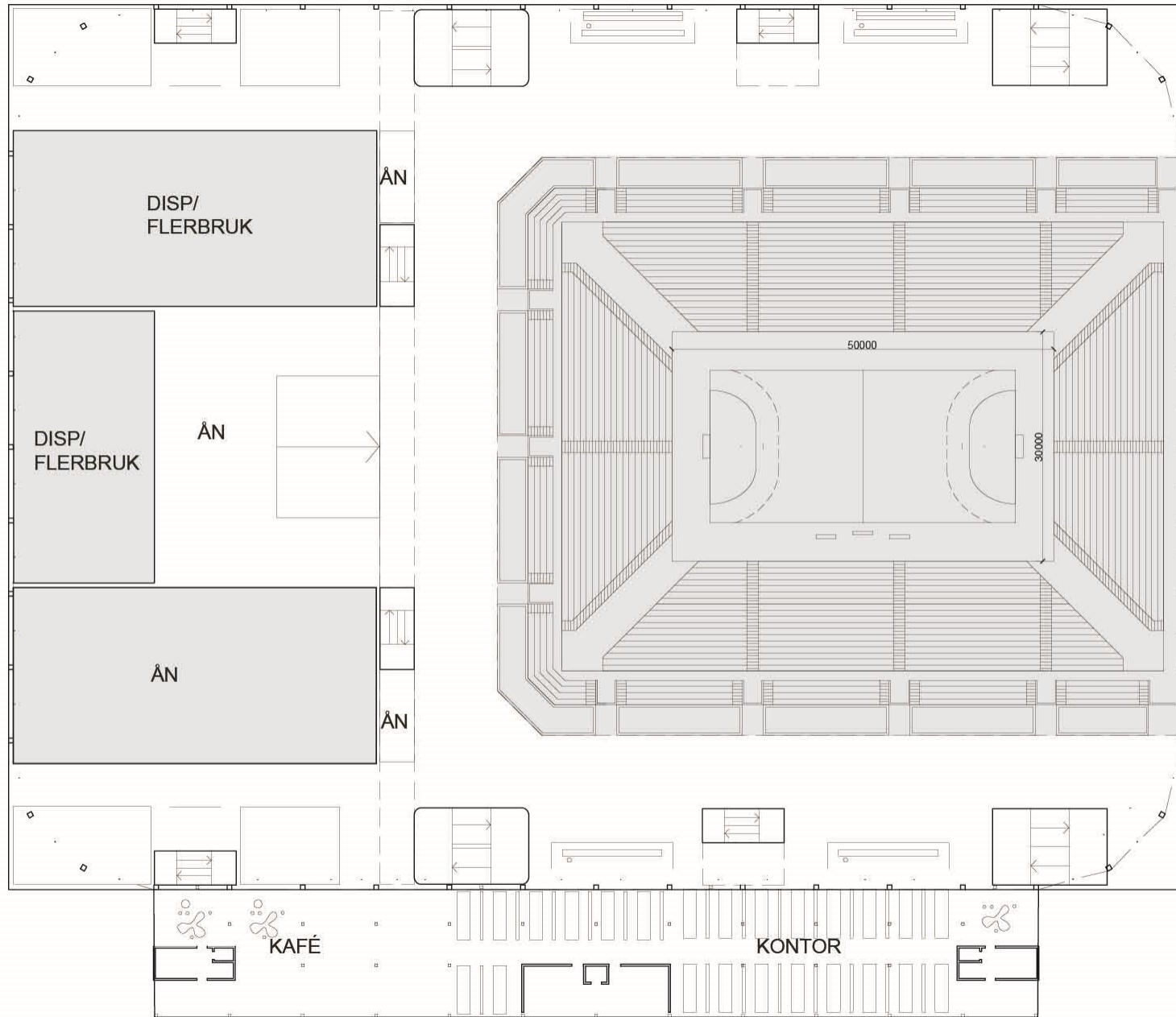

Sameiet  
Widerøeveien 1  
Reiulf  
Ramstad  
Arkitekter  
10.12.20

0 20  
+23.75



# PLAN 3

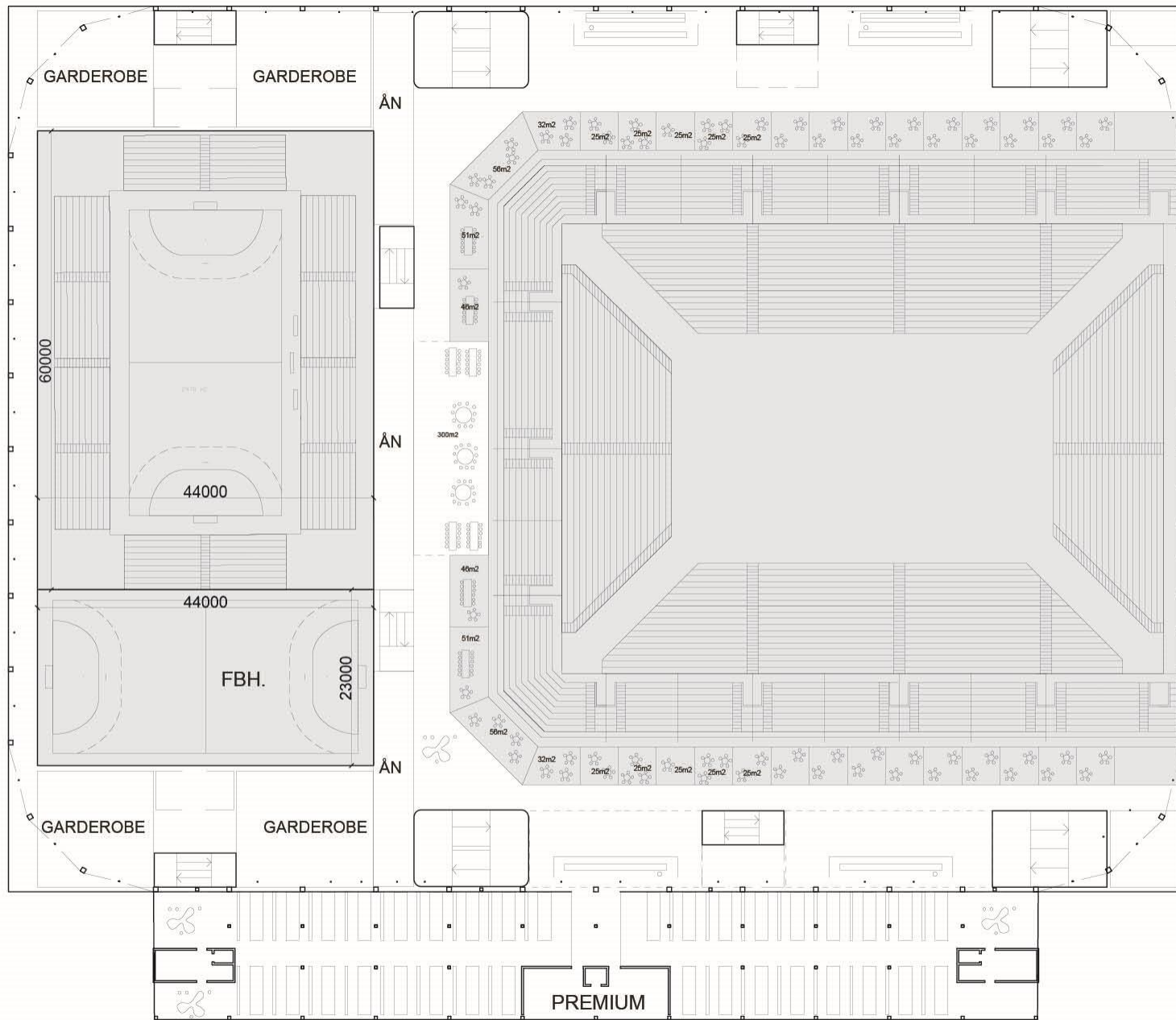

Sameiet  
Widerøveien 1  
Reiulf  
Ramstad  
Arkitekter  
10.12.20

0 20  
+28.75



# PLAN 4

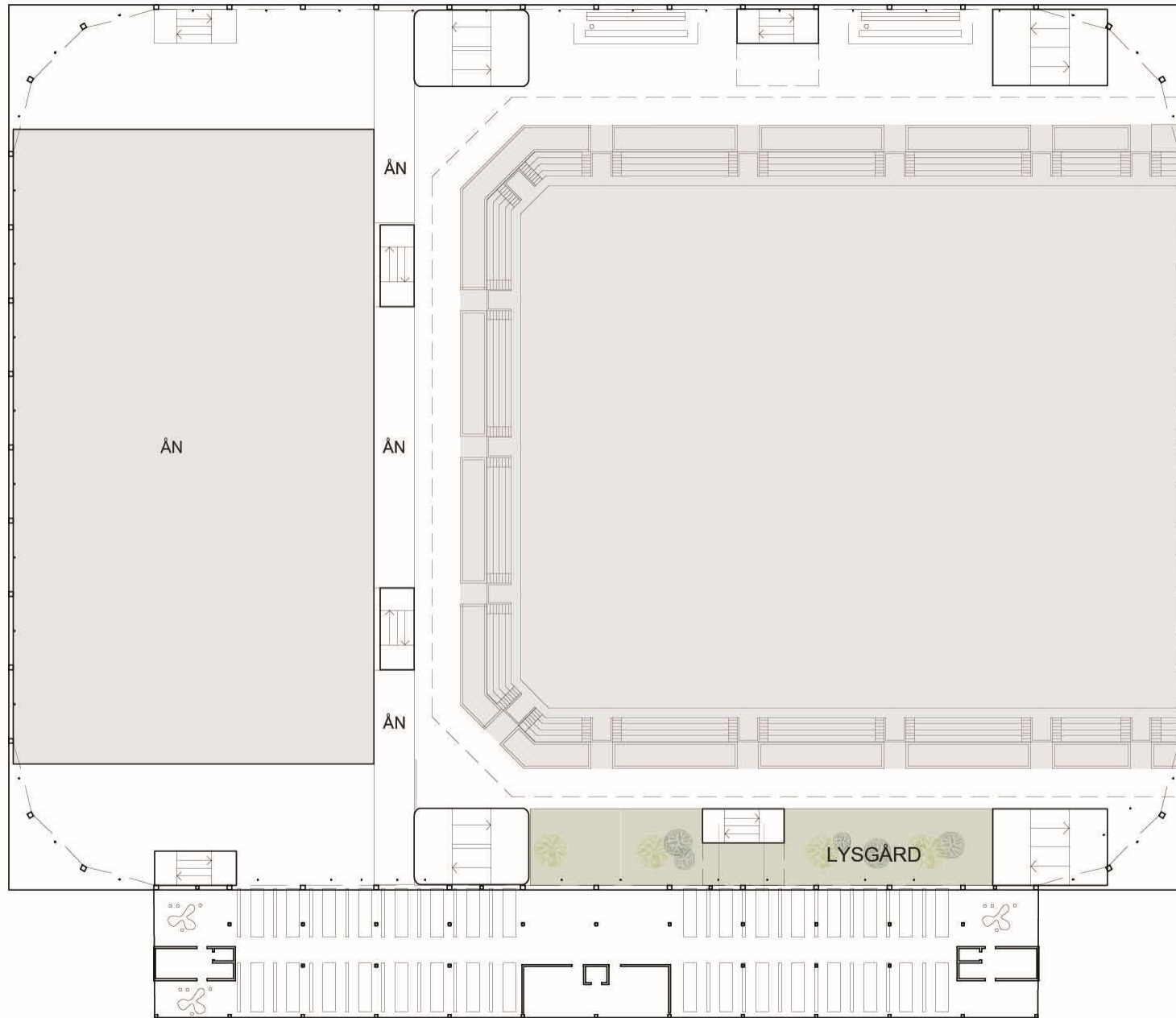

Sameiet  
Widerøeveien 1  
Reiulf  
Ramstad  
Arkitekter  
10.12.20

0 20  
+31.95



# PLAN 5

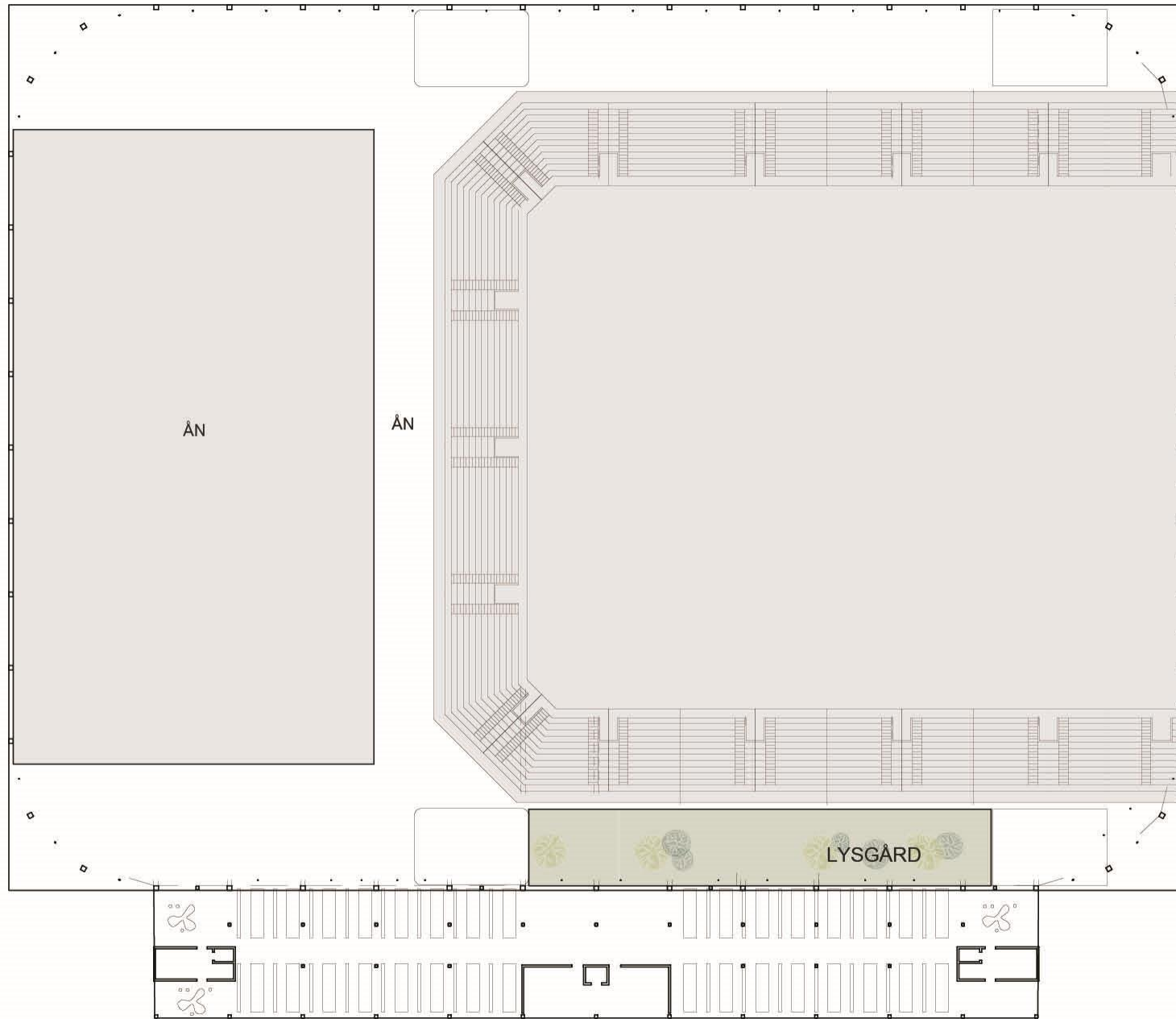

Sameiet  
Widerøveien 1  
Reiulf  
Ramstad  
Arkitekter  
10.12.20

0 20  
+39.00



# 2020.12.07 FORNEBU ARENA

TELENOR ARENA

Reiulf  
Ramstad  
Arkitekter

Sameiet  
Widerøeveien 1



**Sameiet  
Widerøveien 1**

Reiulf  
Ramstad  
Arkitekter  
10.12.20